

# Flow Measurement

## SITRANS F M

### Flow sensor MAG 1100 F

#### Overview



The electromagnetic sensor SITRANS F M MAG 1100 F is designed to meet applications in the food and beverage industry.

#### Benefits

- Sensor sizes: DN 10 to DN 100 (3/8" to 4")
- AISI 316 stainless steel enclosure
- Sensor: Hygienic connection, 3A approval and EHEDG certified
- Sanitary design for CIP / SIP cleaning
- Conforms to FDA
- Easy commissioning, the SENSORPROM unit automatically updates settings
- Hose proof IP67/NEMA 4X enclosure rating
- Designed that patented in-situ verification can be conducted. Using SENSORPROM fingerprints

#### Application

The main applications of the SITRANS F M electromagnetic sensors can be found in the following fields:

- Food industry
- Beverage industry
- Pharmaceutical industry

#### Design

- Unique mechanical design with a wide range of customer specified sanitary connection
- Compact or remote mounting possible easy "plug & play" field changeable
- Simple on site upgrade to IP68/NEMA 6P terminal box
- Ex ATEX 2G D version for hazardous areas (ceramic liner)

#### Mode of operation

The flow measuring principle is based on Faraday's law of electromagnetic induction according to which the sensor converts the flow into an electrical voltage proportional to the velocity of the flow.

#### Integration

The complete flowmeter consists of a sensor and an associated transmitter SITRANS F M MAG 5000, 6000 and 6000 I. The flexible communication concept USM II simplifies integration and update to a variety of fieldbus systems such as PROFIBUS DP and PA, Modbus RTU/RS 485, HART, FOUNDATION Fieldbus H1, DeviceNet.

#### Pressure/temperature curve; material AISI 316L/1.4404

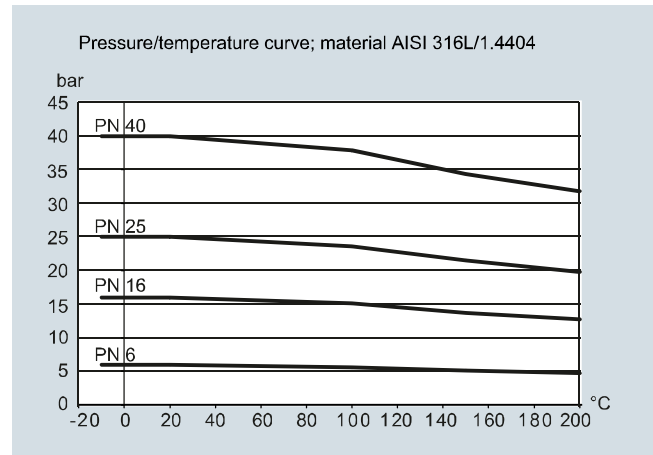

#### Pressure/temperature curve; material AISI 316L/1.4404

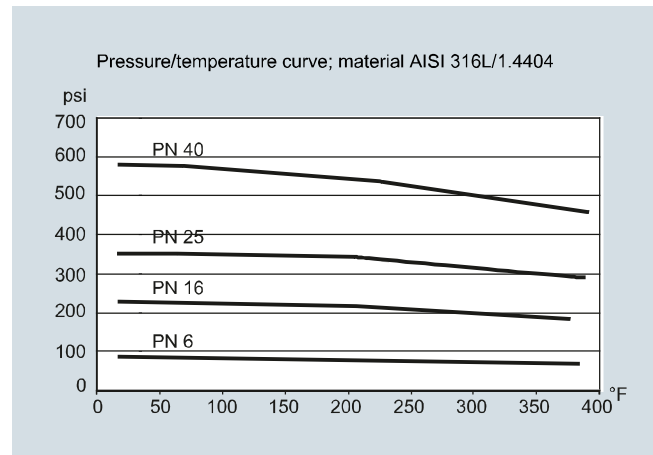

For further information on the PED standard and requirements, see page 9/6.

## Technical specifications

<b>Measuring principle</b> Excitation frequency (Mains supply: 50 Hz/60 Hz)	Electromagnetic induction DN 10 ... 65 (1/4" ... 2 1/2"): 12.5 Hz/15 Hz DN 80 ... 100 (3", 4"): 6.25 Hz/7.5 Hz	<b>Design</b> Weight <u>Material</u> Enclosure • MAG 1100 F Terminal box (remote version only) • Standard • Option • Ex ATEX (remote version only)	See Dimensional drawings  Stainless steel AISI 316L/1.4404  Fibre glass reinforced polyamide Stainless steel AISI 316/1.4436 Stainless steel AISI 316/1.4436
<b>Process connection</b> Nominal size Process connection	DN 10 ... DN 100 (3/8" ... 4") Hygienic adapters available for: • Direct welding onto pipe • Clamp fitting • Threaded fitting	<b>Liner</b> MAG 1100 F (Ceramic) MAG 1100 F (PFA)	Aluminum oxide Al <sub>2</sub> O <sub>3</sub> (ceramics) Reinforced PFA (teflon) (not for Ex)
<b>Rated operating conditions</b> <u>Ambient conditions</u> Ambient temperature <sup>1)</sup> • Sensor • Ex sensor • Compact transmitter MAG 5000/6000 <sup>2)</sup> • Transmitter MAG 6000 I • Compact transmitter MAG 6000 I Ex <u>Temperature of medium</u> MAG 1100 F (Ceramic) MAG 1100 F (PFA) <u>Temperature shock</u> MAG 1100 F • Duration ≤ 1 min, followed by 10 min rest MAG 1100 F (PFA) <u>Operating pressure</u> MAG 1100 F (Ceramic) MAG 1100 F (PFA) <u>Mechanical load (vibration)</u> MAG 1100 F (PFA) <u>Enclosure rating</u> EMC	-40 ... +100 °C (-40 ... +212 °F) -20 ... +60 °C (-4 ... +140 °F) -20 ... +60 °C (-4 ... +140 °F) -20 ... +60 °C (-4 ... +140 °F) -20 ... +60 °C (-4 ... +140 °F) -20 ... +150 °C (-4 ... +302 °F) Suitable for steam sterilization -30 ... +130 °C (-22 ... +266 °F) Suitable for steam sterilization at 150 °C (302 °F)  • DN 10, 15, 25: Max. ΔT ≤ 80 °C/min (3/8", 1/2", 1"): Max. ΔT ≤ 144 °F/min • DN 40, 50, 65: Max. ΔT ≤ 70 °C/min (1 1/2", 2", 2 1/2"): Max. ΔT ≤ 126 °F/min • DN 80, 100: Max. ΔT ≤ 60 °C/min (3", 4"): Max. ΔT ≤ 108 °F/min Max. ± 100 °C (212 °F) momentarily  DN 10 ... 65: 40 bar (3/8" ... 2 1/2"): 580 psi) DN 80: 25 bar (3": 363 psi) DN 100: 25 bar (4": 363 psi) Vacuum: j x 10 <sup>-6</sup> bar <sub>abs</sub> (1.5 x 10 <sup>-5</sup> psi <sub>abs</sub> ) 20 bar (290 psi) Vacuum: 0.02 bar <sub>abs</sub> (0.3 psi <sub>abs</sub> ) DN 80 ... DN 100: CO <sub>2</sub> pressure max. 7 bar (101.5 psi) 18 ... 1000 Hz random in x, y, z, directions for 2 hours according to EN 60068-2-36 Sensor: 3.17 grms Sensor with compact MAG 5000/ 6000 mounted transmitter: 3.17 gr. Sensor with compact MAG 6000 I/MAG 6000 I Ex mounted transmitter: 1.14 grms For compact installation with the MAG 6000 I/MAG 6000 I Ex, trans- mitter to be supported to avoid tension on sensor part. IP67 to EN 60529 (NEMA 4X), 1 mH <sub>2</sub> O for 30 min 2004/108/EC	<b>Electrodes</b> MAG 1100 F (Ceramic) MAG 1100 F (PFA) <b>Cable entries</b> • Remote installation 2 x M20 or 2 x 1/2" NPT • Compact installation - MAG 5000/MAG 6000: 4 x M20 or 4 x 1/2" NPT - MAG 6000 I: 2 x M25 (for sup- ply/output) - MAG 6000 I Ex: 2 x M25 (for supply/output) <b>Certificates and approvals</b> Calibration • Standard Production calibration, calibration report shipped with sen- sor MAG 1100 F (Ceramic) • Ex ATEX approvals for sensor or compact with MAG 6000 I Ex • Sensor with/without MAG 5000/6000/6000 I MAG 1100 F (PFA) Conforms to Custody transfer approvals (MAG 5000/6000 CT)  Zero-point, 2 x 25 %, 2 x 90 %  3A (sensor with Polyamide termi- nal box and FKM/FPM or EPDM gaskets), transmitter not part of the approval ATEX 2G D sensor EEx d e ia IIB T3 - T6 FM Class I, Div 2  3A (sensor with Polyamide termi- nal box with EPDM gasket), trans- mitter not part of the approval EHEDG certified (use EPDM gasket) (DN 25 ... 100 (1 ... 4")) FM Class I, Div 2 Hygienic EC 1925:2003 European food contact material  • PED – 97/23/EC <sup>3)</sup> • CRN (PFA) • FDA  • Cold water pattern approval PTB (Germany) • Hot water pattern approval PTB (Germany) • Other media than water pattern approval- OIML R 117 (Ceramic liner)(Denmark)	

1) Conditions are also dependent on liner characteristics.  
2) With compact transmitter MAG 5000 CT/6000 CT -20 ... +50 °C  
(-4 ... +122 °F)  
3) For further information on the PED standard and requirements, see  
page 9/6.

# Flow Measurement

## SITRANS F M

### Flow sensor MAG 1100 F

#### Accessories

##### Weld-in adapter

Adapter for welding onto dairy pipe Tri-Weld, ISO 2037, DIN 11850, SMS 3008, BS 4825-1

- DN 10, 15, 25, 40, 50 and 65 (3/8", 1/2", 1", 1 1/2", 2" and 2 1/2") PN 40 (600 psi)
- DN 80 and DN 100 (3" and 4") PN 25 (350 psi)

##### Clamp adapter

Tri-Clamp, ISO 2852, DIN 32676, SMS 3016, BS 4825-3

- DN 10, 15, 25, 40 and 50 (3/8", 1/2", 1", 1 1/2", and 2") PN 16 (200 psi)
- DN 65, 80 and 100 (2 1/2", 3" and 4") PN 10 (150 psi)

##### Thread adapter

DIN 11851

- DN 10, 15, 25, and 40 (3/8", 1/2", 1", and 1 1/2") PN 40 (600 psi)

- DN 50, 65, 80 and 100 (2", 2 1/2", 3" and 4") PN 25 (350 psi)

ISO 2853, BS 4825-4

- DN 10, 15, 25, 40, 50, 65 and 80 (3/8", 1/2", 1", 1 1/2", 2", 2 1/2" and 3") PN 16 (200 psi)

SMS 1145

- DN 25, 40, 50, 65 and 80 (1", 1 1/2", 2", 2 1/2" and 3") PN 6 (80 psi)

#### Design

##### Material

Adapter Stainless steel AISI 316/1.4436

Gasket

- MAG 1100 F (Ceramic) FKM/FPM with stainless steel insert (AISI 304/1.4301) (-20 ... +150 °C (-4 ... +302 °F))
- MAG 1100 F (PFA) EPDM (-20 ... +150 °C (-4 ... +302 °F))  
NBR (-20 ... +100 °C (-4 ... +212 °F))

#### Note:

When combined sensor and adapter, the operating pressure is the lower rated of the pair.

#### Selection and Ordering data

##### Sensor SITRANS F M MAG 1100 F

Article No.

7ME6140-

##### Diameter

- DN 10 (3/8") 1 R
- DN 15 (1/2") 1 V
- DN 25 (1") 2 D
- DN 40 (1 1/2") 2 R
- DN 50 (2") 2 Y
- DN 65 (2 1/2") 3 F
- DN 80 (3") 3 M
- DN 100 (4") 3 T

##### Process connections

No adaptors (specials see accessories) A

##### Weld in

- DIN 11850 B
- ISO 2037 (SMS 3008) C
- BS 4825-1 D
- Tri-Weld E

##### Clamp type

- DIN 32676 G
- ISO 2852 (SMS 3016) H
- BS 4825-3 J
- Tri-Clamp K

##### Threaded type

- DIN 11851 M
- SMS 1145<sup>1)</sup> N

##### Liner material

- PFA (not for Ex) 1
- Ceramic 2

##### Gasket material<sup>1)</sup>

- EPDM flat gasket (FDA, 3A) 0
- FPM/FKM (FDA, 3A) (only with ceramic liner) 2
- EPDM-P gasket (only for PFA) (FDA, EHEDG certified, 3A) 3

##### Electrode material

- Hastelloy C (only with PFA liner) 1
- Platinum (only with ceramic liner) 2

##### Transmitter

- Standard sensor for remote transmitter (order transmitter separately), 3A A
- Ex sensor for remote transmitter (order transmitter separately) 3A B
- MAG 6000 I, Alu. 18 ... 90 V DC, 115 ... 230 V AC C
- MAG 6000 I, Aluminum 18 ... 30 V DC, Ex D
- MAG 6000 I, Aluminum 115 ... 230 V AC, Ex E
- MAG 6000, Polyamide, 11 ... 30 V DC/11 ... 24 V AC H
- MAG 6000, Polyamide, 115 ... 230 V AC J
- MAG 5000, Polyamide, 11 ... 30 V DC/11 ... 24 V AC K
- MAG 5000, Polyamide, 115 ... 230 V AC L

##### Communication





- No communication, add-on possible A
- HART B
- PROFIBUS PA Profile 3 F
- (only MAG 6000/MAG 6000 I)
- PROFIBUS DP Profile 3 (not for Ex) G
- (only MAG 6000/MAG 6000 I)
- Modbus RTU/RS 485 (not for Ex) E
- (only MAG 6000/MAG 6000 I)
- FOUNDATION Fieldbus H1 J
- (only MAG 6000/MAG 6000 I)

<sup>1)</sup> SMS 1145 standard is not approved by 3A

# Flow Measurement

## SITRANS F M

### Flow sensor MAG 1100 F

Selection and Ordering data	Article No.
<b>Sensor SITRANS F M MAG 1100 F</b>	<b>7 ME 6 1 4 0 -</b>
	
<b>Cable glands/terminal box</b>	
Metric: Polyamide terminal box or 6000 I compact 	<b>1</b>
½" NPT: Polyamide terminal box or 6000 I compact 	<b>2</b>
Metric: SS terminal box (mandatory for Stainless steel MAG 6000 Transmitter)	<b>3</b>
½" NPT: SS terminal box (mandatory for Stainless steel MAG 6000 Transmitter)	<b>4</b>
 We can offer shorter delivery times for configurations designated with the Quick Ship Symbol  . For details see page 9/5 in the appendix.	

Selection and Ordering data	Order code
<b>Additional information</b>	
Please add <b>"-Z"</b> to Article No. and specify Order code(s) and plain text.	
Customer-specific converter setup	<b>Y20</b>
Tag name plate, stainless steel fixed with SS wire (add plain text)	<b>Y17</b>
Tag name plate, plastic (self adhesive)	<b>Y18</b>
Factory certificate according to EN 10204-2.2	<b>C14</b>
Factory certificate according to EN 10204-2.1	<b>C15</b>
Sensor cables wired (specify cable Article No.)	<b>Y40</b>
Sensor for remote transmitter's junction box potted with wired cable (specify cable Article No.) (not for Ex sensors)	<b>Y41</b>
Other postproduction requirements (add desired text)	<b>Y99</b>
Additional calibrations	
<ul style="list-style-type: none"> <li>Matched pair - (Standard production calibration where sensor and transmitter is calibrated together)</li> </ul>	<b>On request<sup>1)</sup></b>
<ul style="list-style-type: none"> <li>Customer-specified calibration up to 10 points</li> </ul>	<b>On request<sup>1)</sup></b>
<ul style="list-style-type: none"> <li>Customer-witnessed calibration</li> <li>Any of above calibration</li> </ul>	<b>On request<sup>1)</sup></b>
<sup>1)</sup> Ordering "On request" as dedicated information from the customer on the individual sensors is required. Please fill in the calibration form found on <a href="http://ntranet.automation.siemens.com/w1/automation-technology-flow-measurement-18626.htm#content-19336&amp;para1=Flow%20Measurement">http://ntranet.automation.siemens.com/w1/automation-technology-flow-measurement-18626.htm#content-19336&amp;para1=Flow%20Measurement</a> and send together with the order. (Size dependent restriction on maximum flow rates may apply)	



### Operating instructions for SITRANS F M MAG 1100F



Description	Article No.
Handbook	
• English	<b>A5E02435647</b>
This device is shipped with a Quick Start guide and a CD containing further SITRANS F literature.	
All literature is also available for free at: <a href="http://www.siemens.com/flowdocumentation">http://www.siemens.com/flowdocumentation</a>	

MAG 5000/6000 transmitters and sensors are packed in separate boxes, the final assembly takes place during installation at the customer's place. MAG 6000 I/MAG 6000 I Ex ATEX 2G D transmitters and sensors are delivered compact mounted from factory. Communication module will be pre-mounted in the transmitter.

Please use online Product selector to get latest updates.  
 Product selector link:  
[www.pia-selector.automation.siemens.com](http://www.pia-selector.automation.siemens.com)

### Accessories

Description	Article No.
Potting kit for terminal box of flow sensors for IP68/NEMA 6P (not for Ex sensors) 	<b>FDK:085U0220</b>
	

 We can offer shorter delivery times for configurations designated with the Quick Ship Symbol . For details see page 9/5 in the appendix.

# Flow Measurement

## SITRANS F M

### Flow sensor MAG 1100 F

#### Accessories Article No.

##### Weld-in connection fittings for MAG 1100 F with P gaskets for EHEDG<sup>3)</sup>

Only for sensors with PFA liner.

2 pcs. fittings

2 pcs. clamps (to join flow sensor and fitting)

##### DIN 11850

Adapter			Sensor
DN (mm)	D <sub>o</sub> (mm)	D <sub>T</sub> (mm)	DN (mm)

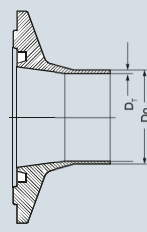

10 <sup>2)</sup>	13	1.5	10	◆ A5E02054630
15 <sup>2)</sup>	19	1.5	15	◆ A5E02054633
20	23	1.5	15	◆ A5E02054634
25	29	1.5	25	◆ A5E02054635
32	35	1.5	25	◆ A5E02054637
40	41	1.5	40	◆ A5E02054638
50	53	1.5	50	◆ A5E02054640
65	70	2.0	65	◆ A5E02054643
80	85	2.0	80	◆ A5E02054644
100	104	2.0	100	◆ A5E02054646

##### ISO 2037

Adapter			Sensor
DN (mm)	D <sub>o</sub> (mm)	D <sub>T</sub> (mm)	DN (mm)

12.7	12.7	1.0	10	◆ A5E03727946
17.2	17.2	1.0	15	◆ A5E03728098
25	25	1.6	25	◆ A5E02196073
33	33.7	1.6	25	◆ A5E02196074
38	38	1.6	40	◆ A5E02196075
40	40	1.6	40	◆ A5E02196076
51	51	1.6	50	◆ A5E02196077
63.5	63.5	1.6	65	◆ A5E02196078
76.1	76.1	1.6	80	◆ A5E02196080
101.6	101.6	2.0	100	◆ A5E02196082

##### Tri-Weld (BS 4825-1)

Adapter			Sensor
DN (mm)	D <sub>o</sub> (mm)	D <sub>T</sub> (mm)	DN (mm)

12.7	12.7	1.2	10	◆ A5E02199113
19.05	19.05	1.2	15	◆ A5E02199114
25.4	25.4	1.6	25	◆ A5E02199115
38.1	38.1	1.6	40	◆ A5E02199116
50.8	50.8	1.6	50	◆ A5E02199117
63.5 <sup>1)</sup>	63.5	1.6	65	◆ A5E02199118
76.2	76.2	1.6	80	◆ A5E02199119
101.6 <sup>1)</sup>	101.6	2.0	100	◆ A5E02199120

◆ We can offer shorter delivery times for configurations designated with the Quick Ship Symbol ◆. For details see page 9/5 in the appendix.

D<sub>o</sub>: Outer diameter

D<sub>i</sub>: Inner diameter

<sup>1)</sup> For BS 4825-1 see ISO 2037

<sup>2)</sup> Not EHEDG approved

<sup>3)</sup> P gaskets not included

#### Accessories Article No.

##### Clamp-type connection fittings for MAG 1100 F with P gaskets for EHEDG<sup>3)</sup>

Only for sensors with PFA liner.

2 pcs. fittings

2 pcs. clamps (to join flow sensor and fitting)

##### DIN 32676

Adapter			Sensor
DN (mm)	D <sub>o</sub> (mm)	D <sub>i</sub> (mm)	DN (mm)

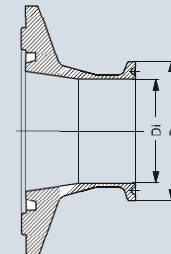

10	34	10	10	◆ A5E02211143
15	34	16	15	◆ A5E02211144
25	50.5	22.6	25	◆ A5E02211146
40	50.5	38	40	◆ A5E02211147
50	64	50	50	◆ A5E02211148
65	91	66	65	◆ A5E02211151
80	106	81	80	◆ A5E02211152
100	119	100	100	◆ A5E02211153

##### ISO 2852

Adapter			Sensor
DN (mm)	D <sub>o</sub> (mm)	D <sub>i</sub> (mm)	DN (mm)

25	50.5	22.6	25	◆ A5E02213581
33.7	50.5	31.3	25	◆ A5E02213582
38	50.5	35.6	40	◆ A5E02213583
51	64	48.6	50	◆ A5E02213584
63.5	77.5	60.3	65	◆ A5E02213585
76.1	91	72.9	80	◆ A5E02213586
101.6	119	97.6	100	◆ A5E02213587

##### Tri-Clamp (BS 4825-3)

Adapter			Sensor
DN (mm)	D <sub>o</sub> (mm)	D <sub>i</sub> (mm)	DN (mm)

12.7	25.4	9.5	10	◆ A5E02213596
19.05	25.4	15.85	15	◆ A5E02213597
25.4	50.5	22.2	25	◆ A5E02213598
38.1	50.5	34.9	40	◆ A5E02213599
50.8	64	47.6	50	◆ A5E02213600
63.5	77.5	60.3	65	◆ A5E02213601
76.2	91	73	80	◆ A5E02213602
101.6	119	97.6	100	◆ A5E02213603

D<sub>o</sub>: Outer diameter

D<sub>i</sub>: Inner diameter

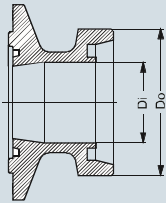
Accessories				Article No.
<b>Threaded type connection fittings for MAG 1100 F with P gaskets for EHEDG<sup>2)</sup></b>				
Only for sensors with PFA liner.				
2 pcs. fittings				
2 pcs. clamps (to join flow sensor and fitting)				
<b>DIN 11851</b>				
<u>Adapter</u>		<u>Sensor</u>		
DN (mm)	D <sub>o</sub> (mm)	D <sub>i</sub> (mm)	DN (mm)	
				
10	28	10	10	<b>A5E02218293</b>
15	34	16	15	<b>A5E02218294</b>
20	44	20	15	<b>A5E02218295</b>
25	52	26	25	◆ <b>A5E02218296</b>
32	58	32	25	<b>A5E02218297</b>
40	65	38	40	◆ <b>A5E02218298</b>
50	78	50	50	◆ <b>A5E02218299</b>
65	95	66	65	<b>A5E02218300</b>
80	110	81	80	<b>A5E02218301</b>
100	130	100	100	<b>A5E02218302</b>

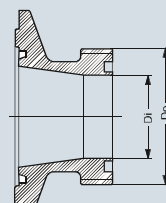
Accessories				Article No.
<b>Threaded type connection fittings for MAG 1100 F with P gaskets for EHEDG<sup>2)</sup></b>				
Only for sensors with PFA liner.				
2 pcs. fittings				
2 pcs. clamps (to join flow sensor and fitting)				
<b>SMS 1145<sup>1)</sup></b>				
<u>Adapter</u>		<u>Sensor</u>		
DN (mm)	D <sub>o</sub> (mm)	D <sub>i</sub> (mm)	DN (mm)	
				
25	40	22.6	25	<b>A5E02218310</b>
38	60	35.6	40	<b>A5E02218312</b>
51	70	48.6	50	<b>A5E02218313</b>
63.5	85	60.3	65	<b>A5E02218314</b>
76	98	72	65	<b>A5E02218315</b>
◆ We can offer shorter delivery times for configurations designated with the Quick Ship Symbol ◆. For details see page 9/5 in the appendix.				
D <sub>o</sub> : Outer diameter				
D <sub>i</sub> : Inner diameter				
1) SMS 1145 standard is not approved by 3A				
2) P gaskets not included				

# Flow Measurement

## SITRANS F M

### Flow sensor MAG 1100 F

#### Accessories

Article No.

#### Weld in connection fittings for MAG 1100 F with flat gaskets for 3A<sup>2)</sup>

For sensors with ceramic and PFA liner.

2 pcs. fittings

2 pcs. clamps (to join flow sensor and fitting)

#### DIN 11850

Adapter			Sensor
DN (mm)	D <sub>o</sub> (mm)	D <sub>T</sub> (mm)	DN (mm)

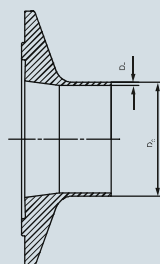

10	13	1.5	10	◆ FDK:083G2116
15	19	1.5	15	◆ FDK:083G2117
20	23	1.5	15	◆ FDK:083G2118
25	29	1.5	25	◆ FDK:083G2119
32	35	1.5	25	◆ FDK:083G2120
40	41	1.5	40	◆ FDK:083G2121
50	53	1.5	50	◆ FDK:083G2122
65	70	2.0	65	◆ FDK:083G2123
80	85	2.0	80	◆ FDK:083G2124
100	104	2.0	100	◆ FDK:083G2125

#### ISO 2037

Adapter			Sensor
DN (mm)	D <sub>o</sub> (mm)	D <sub>T</sub> (mm)	DN (mm)

12.7	12.7	1.0	10	A5E03720273
17.2	17.2	1.0	15	◆ FDK:083G2107
25	25.6	1.6	25	◆ FDK:083G2109
33.7	33.7	1.6	25	◆ FDK:083G2100
38	38	1.6	40	◆ FDK:083G2111
40	40	1.6	40	◆ FDK:083G2101
51	51	1.6	50	◆ FDK:083G2112
63.5	63.5	1.6	65	◆ FDK:083G2113
76.1	71.1	1.6	80	◆ FDK:083G2114
101.6	101.6	2.0	100	◆ FDK:083G2115
114.3	118.3	2.0	100	◆ FDK:083G2105

#### Tri-Weld (BS 4825-1)

Adapter			Sensor
DN (mm)	D <sub>o</sub> (mm)	D <sub>T</sub> (mm)	DN (mm)

12.7	12.7	1.2	10	◆ FDK:083G2276
19.05	19.05	1.2	15	◆ FDK:083G2277
25.4	25.4	1.6	25	◆ FDK:083G2279
38	38.1	1.6	40	◆ FDK:083G2281
50.8	50.8	1.6	50	◆ FDK:083G2282
63.5 <sup>1)</sup>	63.5	1.6	65	◆ FDK:083G2283
76.2	76.2	1.6	80	◆ FDK:083G2284
101.6 <sup>1)</sup>	101.6	2.0	100	◆ FDK:083G2285

◆ We can offer shorter delivery times for configurations designated with the Quick Ship Symbol ◆. For details see page 9/5 in the appendix.

D<sub>o</sub>: Outer diameterD<sub>i</sub>: Inner diameter

1) For BS 4825-1 see ISO 2037

2) Flat gaskets not included

#### Accessories

Article No.

#### Clamp-type connection fittings for MAG 1100 F with flat gaskets for 3A<sup>2)</sup>

For sensors with ceramic and PFA liner.

2 pcs. fittings

2 pcs. clamps (to join flow sensor and fitting)

#### DIN 32676

Adapter			Sensor
DN (mm)	D <sub>o</sub> (mm)	D <sub>T</sub> (mm)	DN (mm)

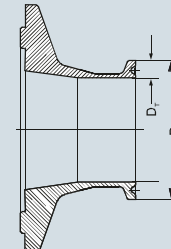

10	34	10	10	◆ FDK:083G2186
15	34	16	15	◆ FDK:083G2187
25	50.5	26	25	◆ FDK:083G2179
40	50.5	38	40	◆ FDK:083G2181
50	64	50	50	◆ FDK:083G2182
65	91	66	65	◆ FDK:083G2183
80	106	81	80	◆ FDK:083G2184
100	119	100	100	◆ FDK:083G2185

#### ISO 2852

Adapter			Sensor
DN (mm)	D <sub>o</sub> (mm)	D <sub>T</sub> (mm)	DN (mm)

25	50.5	22.6	25	◆ FDK:083G2189
33.7	50.5	31.3	25	◆ FDK:083G2190
38	50.5	35.6	40	◆ FDK:083G2191
51	64	48.6	50	◆ FDK:083G2192
63.5	77.5	60.3	65	◆ FDK:083G2193
76.1	91	72.9	80	◆ FDK:083G2194
101.6	119	97.6	100	◆ FDK:083G2195

#### Tri-Clamp (BS 4825-3)

Adapter			Sensor
DN (mm)	D <sub>o</sub> (mm)	D <sub>T</sub> (mm)	DN (mm)

12.7	25.4	9.5	10	◆ FDK:083G2286
19.05	25.4	15.85	15	◆ FDK:083G2287
25.4	50.5	22.2	25	◆ FDK:083G2289
38.1	50.5	34.9	40	◆ FDK:083G2291
50.8	64	47.6	50	◆ FDK:083G2292
63.5	77.5	60.3	65	◆ FDK:083G2293
76.2	91	73	80	◆ FDK:083G2294
101.6	119	97.6	100	◆ FDK:083G2295

D<sub>o</sub>: Outer diameterD<sub>i</sub>: Inner diameter

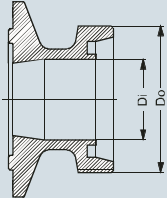
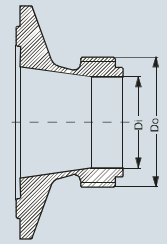
Accessories				Article No.
<b>Threaded type connection fittings for MAG 1100 F with flat gaskets for 3A<sup>2)</sup></b>				
For sensors with ceramic and PFA liner.				
2 pcs. fittings				
2 pcs. clamps (to join flow sensor and fitting)				
<b>DIN 11851</b>				
<u>Adapter</u>		<u>Sensor</u>		
DN (mm)	D <sub>o</sub> (mm)	D <sub>i</sub> (mm)	DN (mm)	
				
10	28	10	10	<b>FDK:083G2156</b>
15	34	16	15	<b>FDK:083G2157</b>
20	44	20	15	<b>FDK:083G2158</b>
25	52	26	25	◆ <b>FDK:083G2159</b>
32	58	32	25	<b>FDK:083G2160</b>
40	65	38	40	◆ <b>FDK:083G2161</b>
50	78	50	50	◆ <b>FDK:083G2162</b>
65	95	66	65	<b>FDK:083G2163</b>
80	110	81	80	<b>FDK:083G2164</b>
100	130	100	100	<b>FDK:083G2165</b>
<b>ISO 2853</b>				
<u>Adapter</u>		<u>Sensor</u>		
DN (mm)	D <sub>o</sub> (mm)	D <sub>i</sub> (mm)	DN (mm)	
				
25	37	22.6	25	<b>FDK:083G2149</b>
38	51	35.6	40	<b>FDK:083G2151</b>
51	64	48.6	50	<b>FDK:083G2152</b>
63.5	78	60.3	65	<b>FDK:083G2153</b>
76.1	91	72.9	80	<b>FDK:083G2154</b>
<b>BS 4825-4</b>				
<u>Adapter</u>		<u>Sensor</u>		
DN (mm)	D <sub>o</sub> (mm)	D <sub>i</sub> (mm)	DN (mm)	
25.4	37	22.2	25	<b>A5E03732429</b>
38.1	51	34.9	40	<b>A5E03732431</b>
50.8	64	47.6	50	<b>A5E03732433</b>
63.5	78	60.3	65	<b>A5E03732434</b>
76.2	91	73	80	<b>A5E03732435</b>
101.6	126	97.6	100	<b>FDK:083G2145</b>

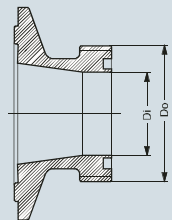
Accessories				Article No.
<b>Threaded type connection fittings for MAG 1100 F with flat gaskets for 3A<sup>2)</sup></b>				
For sensors with ceramic and PFA liner.				
2 pcs. fittings				
2 pcs. clamps (to join flow sensor and fitting)				
<b>SMS 1145<sup>1)</sup></b>				
<u>Adapter</u>		<u>Sensor</u>		
DN (mm)	D <sub>o</sub> (mm)	D <sub>i</sub> (mm)	DN (mm)	
				
25	40	22.6	25	◆ <b>FDK:083G2139</b>
38	60	35.6	40	<b>FDK:083G2141</b>
51	70	48.6	50	◆ <b>FDK:083G2142</b>
63.5	85	60.3	65	<b>FDK:083G2143</b>
76	98	72	65	<b>FDK:083G2144</b>
◆ We can offer shorter delivery times for configurations designated with the Quick Ship Symbol ◆. For details see page 9/5 in the appendix.				
D <sub>o</sub> : Outer diameter				
D <sub>i</sub> : Inner diameter				
1) SMS 1145 standard is not approved by 3A				
2) Flat gaskets not included.				



# Flow Measurement

## SITRANS F M

### Flow sensor MAG 1100 F

#### Spare parts for MAG 1100 F

Article No.

#### Gaskets

(delivered in pairs, to be placed between flow sensor and adapter)

#### MAG 1100 F (PFA) - P gaskets

Rubber: EPDM (FDA)

- DN 10 ◆ A5E02055286
- DN 15 ◆ A5E02055287
- DN 25 ◆ A5E02055290
- DN 40 ◆ A5E02055291
- DN 50 ◆ A5E02055292
- DN 65 ◆ A5E02055293
- DN 80 ◆ A5E02055295
- DN 100 ◆ A5E02055297

#### MAG 1100 F (ceramic) - flat gaskets

Rubber: FKM/FPM (FDA)

- DN 10 ◆ A5E00915707
- DN 15 ◆ A5E00915764
- DN 25 ◆ A5E00915771
- DN 40 ◆ A5E00915773
- DN 50 ◆ A5E00915775
- DN 65 ◆ A5E00915780
- DN 80 ◆ A5E00915782
- DN 100 ◆ A5E00915784

#### MAG 1100 F (PFA) - flat gaskets

Rubber: EPDM (FDA)

- DN 10 ◆ FDK:083G2206
- DN 15 ◆ FDK:083G2207
- DN 25 ◆ FDK:083G2209
- DN 40 ◆ FDK:083G2211
- DN 50 ◆ FDK:083G2212
- DN 65 ◆ FDK:083G2213
- DN 80 ◆ FDK:083G2214
- DN 100 ◆ FDK:083G2215

Rubber: NBR

- DN 10 FDK:083G2216
- DN 15 FDK:083G2217
- DN 25 FDK:083G2219
- DN 40 FDK:083G2221
- DN 50 FDK:083G2222
- DN 65 FDK:083G2223
- DN 80 FDK:083G2224
- DN 100 FDK:083G2225

◆ We can offer shorter delivery times for configurations designated with the Quick Ship Symbol ◆. For details see page 9/5 in the appendix.

## Dimensional drawings

## Sensor MAG 1100 F compact/remote

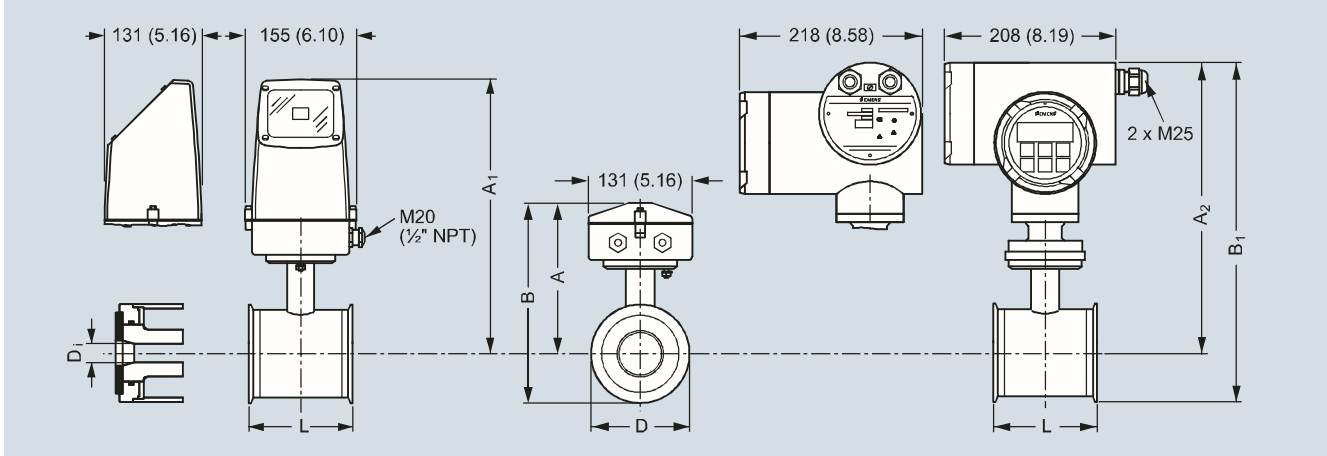

Dimensions in mm (inch)

**Important note:****For compact installation with MAG 6000 I/Ex - Supports the transmitter to avoid tension on the sensor part.**

Size	L	A	A <sub>1</sub> <sup>3)</sup>	B <sup>2)</sup>	B <sub>1</sub>	D	D <sub>1</sub> (Al <sub>2</sub> O <sub>3</sub> )	D <sub>1</sub> PFA	Weight <sup>1)</sup>
DN	[mm]	[mm]	[mm]	[mm]	[mm]	[mm]	[mm]	[mm]	[kg]
10	64	161	315	193.7	344.7	64.0	10	10	2.2
15	64	161	315	193.7	344.7	64.0	15	16	2.2
25	79	169	323	207.5	359.0	77.5	25	26	2.7
40	94	179	333	228.0	379.0	91.0	40	38	3.4
50	104	188	342	247.7	398.7	119.0	50	50	4.2
65	131	197.5	351	262.6	413.6	130.0	65	66	5.5
80	156	204	357	281.0	432.0	155.0	80	81	7.0
100	186	217	370	308.0	459.0	183.0	100	100	10.0

Size	L	A	A <sub>1</sub> <sup>3)</sup>	B <sup>2)</sup>	B <sub>1</sub>	D	D <sub>1</sub> (Al <sub>2</sub> O <sub>3</sub> )	D <sub>1</sub> PFA	Weight <sup>1)</sup>
[inch]	[inch]	[inch]	[inch]	[inch]	[inch]	[inch]	[inch]	[inch]	[lb]
3/8	2.52	6.34	12.40	7.62	13.57	2.52	0.39	0.39	4.8
1/2	2.52	6.34	12.40	7.62	13.57	2.52	0.59	0.63	4.8
1	3.11	6.66	12.72	8.17	14.13	3.05	0.98	1.02	4.9
1 1/2	3.70	7.05	13.11	8.98	14.92	3.58	1.57	1.50	7.5
2	4.09	7.40	13.47	9.75	15.70	4.68	1.97	1.97	9.2
2 1/2	5.16	7.78	13.82	10.34	16.28	5.12	2.56	2.60	12.0
3	6.14	8.03	14.06	11.06	17.01	6.10	3.15	3.19	15.0
4	7.32	8.54	14.57	12.13	18.07	7.20	3.94	3.94	22.0

<sup>1)</sup> With transmitter MAG 5000 or MAG 6000 compact, weight is increased by approximately 0.8 kg (1.8 lb)

With MAG 6000 I weight is increased with 5.5 kg ( 12.1 lb)

<sup>2)</sup> 14.5 mm (0.571") shorter when the AISI terminal box is used (always Ex version)

<sup>3)</sup> A<sub>2</sub> is 3 mm (0.12") shorter than A<sub>1</sub>

# Flow Measurement

## SITRANS F M

### Flow sensor MAG 1100 F

Sensor MAG 1100 F compact/separate – build-in length

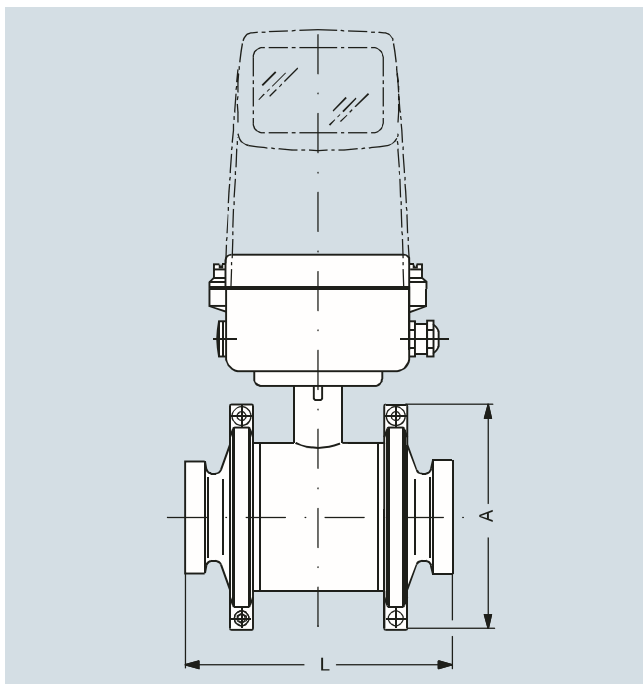

Size		A		L <sup>1)</sup>	
DN	inch	[mm]	[inch]	[mm]	[inch]
10	3/8	99	3.90	146	5.75
15	1/2	99	3.90	146	5.75
25	1	113	4.45	161	6.34
40	1 1/2	126	4.96	176	6.93
50	2	154	6.06	186	7.32
65	2 1/2	165	6.50	223	8.78
80	3	200	7.87	258	10.16
100	4	225	8.86	288	11.34

<sup>1)</sup> The total build-in length "L" is independent of the adapter type selected.